

Lyman®

CYCLONE™ ROTARY TUMBLER

INSTRUCTION GUIDE



Visit our complete Lyman website at
www.lymanproducts.com

WARNING:

This appliance is not intended for use by persons (including children) with reduced physical, sensory, or mental capabilities, or lack of experience and knowledge, unless they have been given supervision or instruction concerning use of the appliance by a person responsible for their safety.

Children should be supervised to ensure they do not play with the appliance.



To reduce the risk of injury, user must read instruction manual



Wear ear protection



Wear eye protection

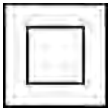

Double insulation



Warning: Do not expose to rain or use in damp locations



Before any work on the machine itself, pull the power plug from the outlet



Wear protective gloves

The Lyman Cyclone Rotary Tumbler takes brass cleaning to a whole new level. The rotary tumbling action combined with the stainless steel media and liquid cleaning solution gets brass cleaner on the outside than vibratory tumbling methods. The small stainless pins easily slip inside cases and into primer pockets to provide superior cleaning action in these areas. Something that vibratory tumblers will not do! The large capacity drum holds up to 1000 pieces of .223 brass and features a rubber lining to protect brass and greatly reduce noise during operation.

Specifications

- Voltage - 230V, 120V +/-10%
- Frequency - 50 Hz
- Operating Current – 0.65A, 1.5A
- FLA – 0.90A, 2.1A
- Power – 80 watts
- Weight of unit –
- Maximum Load in barrel – 13.61kg (30 pounds)
- Speed of barrel – 60 RPM
- Timer Intervals – 1 minute to 180 minutes infinitely adjustable

NOISE and VIBRATION INFORMATION

A weighted sound pressure LpA: 56 dB (A)

A weighted sound power LwA: 67 dB (A)

KpA&KwA: 3.0 dB (A)



Wear ear protection when sound pressure is over: 80dB (A)

The total vibration value is not exceeding 2.5m

Contents

Tumbler drum

Tumbler end cap

Motor base unit

2 sifter pans - 1 large screen and 1 fine screen

2.27kg (5 lbs.) of stainless steel media pins

Sample packet of cleaning solution

Warnings

1. “Warning! When using electric tools, basic safety precautions should always be followed to reduce the risk of fire, electric shock and personal injury including the following.



Read all these instructions before attempting to operate this product and save these instructions”



2. Remove plug from electric outlet when not in use.



3. Do not use the tumbler near a tub or sink where it could fall into water.

4. Do not leave the tumbler running unattended.
5. Do not touch rotating components.
6. Only connect the cord to a properly grounded electrical outlet.
7. Turn the control to the OFF position before removing the drum from the base.
8. Keep hands, hair or loose clothing away from the rotating components.
9. Do not operate on carpet, only on a hard flat floor surface.
10. Do not tumble loaded ammunition or cases with live primers.
11. Do not exceed 13.61kg (30 pounds) maximum load volume in the rotary barrel.
12. For adult use only; keep away from children.
13. Keep work area clear
 - a. Cluttered areas and benches invite injuries.
 - b. Consider your work environment when operating this unit





14. Do not expose tools to rain.





15. Do not use tools in damp or wet locations.

16. Keep work area well lit.
17. Do not use tools in the presence of flammable liquids or gases.
18. Guard against electric shock

Lyman Product's Cyclone Rotary Tumbler Instructions Manual

- a. Avoid body contact with earthed or grounded surfaces (e.g. pipes, radiators, ranges, refrigerators).
19. Keep other persons away
- a. Do not let persons, especially children, not involved in the work touch the tool or the extension cord and keep them away from the work area
20. Tooling
- a. Store idle tools in a safe location without power.
 - b. When not in use, tools should be stored in a dry locked-up place, out of reach of children.
 - c. Keep cutting tools sharp and clean for better and safer performance.
 - d. Maintain tools with care
 - e. Do not force the tool
 - f. It will do the job better and safer at the rate for which it was intended.
 - g. Use the right tool for the job.
 - h. Do not force small tools to do the job of a heavy duty tool.
 - i. Do not use tools for purposes not intended; for example do not use circular saws to cut tree limbs or logs.
21. Dress properly
- a. Do not wear loose clothing or jewelry, they can be caught in moving parts.
 -  b. Non-skid footwear is recommended when working outdoors.
 - c. Wear protective hair covering to contain long hair.
22. Use protective equipment
-  a. Use safety glasses.
 - b. Use dust mask if working operations create dust.
23. Do not abuse the cord
- a. Never yank the cord to disconnect it from the socket Keep the cord away from heat, oil and sharp edges.
24. Secure work
- a. Where possible use clamps or a vice to hold the work. It is safer than using your hand.
25. Do not overreach
26. Keep proper footing and balance at all times.
-  27. Follow instruction for lubricating and changing accessories.
28. Inspect tool cords periodically and if damaged have them repaired by a factory authorized service facility.

29. Inspect extension cords periodically and replace if damaged.
30. Keep handles dry, clean and free from oil and grease.
31. Disconnect tools
 -  a. When not in use, before servicing and when changing accessories such as blades, bits and cutters, disconnect tools from the power supply.
32. Remove adjusting keys and wrenches
 - a. Form the habit of checking to see that keys and adjusting wrenches are removed from the tool before turning it on.
33. Avoid unintentional starting
 - a. Ensure switch is in "off" position when plugging in
34. Use of outdoor extension leads
 - a. When the tool is used outdoors, use only extension cords intended for outdoor use and so marked.
35. Stay alert
 - a. Watch what you are doing, use common sense and do not operate the tool when you are tired.
36. Check damaged parts
 - a. Before further use of tool, it should be carefully checked to determine that it will operate properly and perform its intended function.
 - b. Check for alignment of moving parts, binding of moving parts, breakage of parts, mounting and any other conditions that may affect its operation.
 -  c. A guard or other part that is damaged should be properly repaired or replaced by an authorized service center unless otherwise indicated in this instruction manual.
 - d. Have defective switches replaced by an authorized service center.
 - e. Do not use the tool if the switch does not turn it on and off.

!! Warning !!

-  1. The use of any accessory or attachment other than one recommended in this instruction manual may present a risk of personal injury.
2. Have your tool repaired by a qualified person
3. This electric tool complies with the relevant safety rules. Repairs should only be carried out by qualified persons using original spare parts, otherwise this may result in considerable danger to the user.

4. If the replacement of the supply cord is necessary, this has to be done by the manufacturer or his agent in order to avoid a safety hazard.

Operation Instructions

There are two methods of cleaning cases when using the Cyclone Rotary Tumbler. The first is to tumble fired cases with water and solution only, before any resizing or decapping operations. Then after cases are resized, deprimed, trimmed and deburred; they can be tumbled a second time with water, solution and pins. This will remove case lube from the brass, clean the primer pockets and the inside of the cases, as well as polish their outside surfaces. The advantage to this method is that the initial cleaning will remove the bulk of the dirt from the cases, as well as remove lube and further polish the cases in the second step. It will also reduce the total time needed when tumbling cases. A 15 minute initial cycle will be all that is needed to remove the bulk of the dirt from the brass. Then after resizing, tumbling with pins will only require another ½ hour to 1 hour tumbling time (depending upon how much brass is placed in the bowl). You will however need to dry the cases twice with this method. If using this method, you can disregard the step concerning the use of the media pins in the instructions below during the initial cleaning cycle.

The second method would be to removing spent primers from your fired cases first, and then tumbling them with water, solution and media pins. This will allow the primer pockets to be cleaned and any dirt or grit removed from the cases before reloading. It will also give the cases a bright, uniform polish. The Lyman Universal Decapping die is a perfect tool for removing spent primers. The advantage to this method is that only one tumbling cycle is needed. The disadvantage is that you may need to tumble case for 1 to 3 hours, depending upon how many cases are tumbled at one time.

The instructions below describe tumbling cases with stainless steel media pins.

1. Stand the drum on end and remove the end cap.
2. Add dirty, deprimed brass to the drum. A load that fills ½ of the drum will provide optimum tumbling results. This level will provide that fastest cleaning and best polish. Do not fill the drum more the ¾ of its height with the cases, as the tumbling action will be reduced.
3. Add 2.27kg (5 lbs.) of stainless steel media pins to the drum.
4. Fill the drum with water so that it covers the cases.
5. Add 1 ounce of brass cleaning solution. Lyman Turbo Sonic/Rotary Case Cleaning solution works great in the tumbler.

6. Place the end cap onto the drum and tighten securely. Turn over the drum so that the end cap is facing down and check for any leaks. If any are found, tighten the ring further. If leak persists, remove end cap and wipe off the top edge of the drum and the sealing gasket inside of the end cap. Dirt or debris on these surfaces can cause leaks.
7. With the tumbler base turned off, place the drum onto the rollers.
8. Turn the timer knob to the desired run time and the machine will begin to rotate the drum. It will automatically shut-off when the set run time is reached. Generally, if the drum is full or nearly full, a longer run time will be required versus a lower quantity. This is because a full drum will have less tumbling action than one that is not completely filled. We recommend the bowl be $\frac{1}{2}$ filled for best action. Usually 1 to 2 hours would be required for a half load and 2 to 3 hours for a full load.
9. When the tumbling cycle is completed and the unit shuts-off, remove the drum from the base and take it to a sink, along with the two supplied sifter pans. Note: DO NOT leave cases soaking in the cleaning solution after the cleaning cycle is completed as they can become discolored.
10. Stack the large screen on top of the fine screen pan, and place the assembly into the sink.
11. Remove the end cap from the drum and pour the contents of the drum into the stacked sifter pans. The cases will be caught by the top sifter pan, while the fine screen pan will catch the media pins.
12. Refill the drum with water several times and pour into the sifter pans. This will help remove and pins still inside of the drum, while also helping to wash out pins inside of the cases.
13. Run additional water over the cases while agitating the cases to remove additional pins inside of the cases.



14. Note: the Lyman Case/Media Separator also does an excellent job separating the pins from the cases. The water and pins in the Separator base can then be poured into the fine screen sifter pan to retrieve the pins.
15. Once the pins are separated from the cases, lay the cases on a towel to dry. The use of a blow dryer will speed to drying process.
16. Media pins should also be dried in a similar fashion before storing them for future use. Pins can be used repeatedly without any loss of cleaning action.

Maintenance

Your Lyman Cyclone Rotary tumbler is designed for long life with no need for major service. The basic use and maintenance should include wiping down of unit and keeping all major surfaces clean and dry for proper operation. The only serviceable part on this tumbling unit is the synchronous drive belt.

The following method should be used to replace this item:

1. "Warning ! When using electric tools, basic safety precautions should always be followed to reduce the risk of fire, electric shock and personal injury including the following.



When servicing any unit, please remove the plug from the power source and verify there is no electricity present at the motor.

- a. Remove bottom cover by removing six fasteners.
- b. Remove 4 motor mounting screws.
- c. Slide motor towards center of base housing.
- d. Remove synchronous drive belt from driven pulleys and discard.
- e. Install new drive belt onto pulleys.
- f. Tension belt by sliding motor on elongated holes on motor base.
- g. The drive belt should have approximately a 6mm (1/4") amount of deflection when pushing on the belt.
- h. Tighten motor mounting screws.
- i. Replace bottom cover with 6 screw.

A	Tumbler Drum	7631450
B	Cap, Tumbler Drum	7631452
C	Rubber Gasket, Tumbler Drum	7631451
D	Synchronous Drive Belt	7631453
E	Rubber Foot	7631454
F	Power Cord	
	115V	7631457
	230V	7631458
	230V Aust	7631459
	230V UK	7631460
G	Coarse Sifter	7631455
H	Fine Sifter	7631456
I	Sifter Set	7631314
J	Stainless Steel Media, 2.27kg (5lb.)	7631375

Lyman Product's Cyclone Rotary Tumbler Instructions Manual

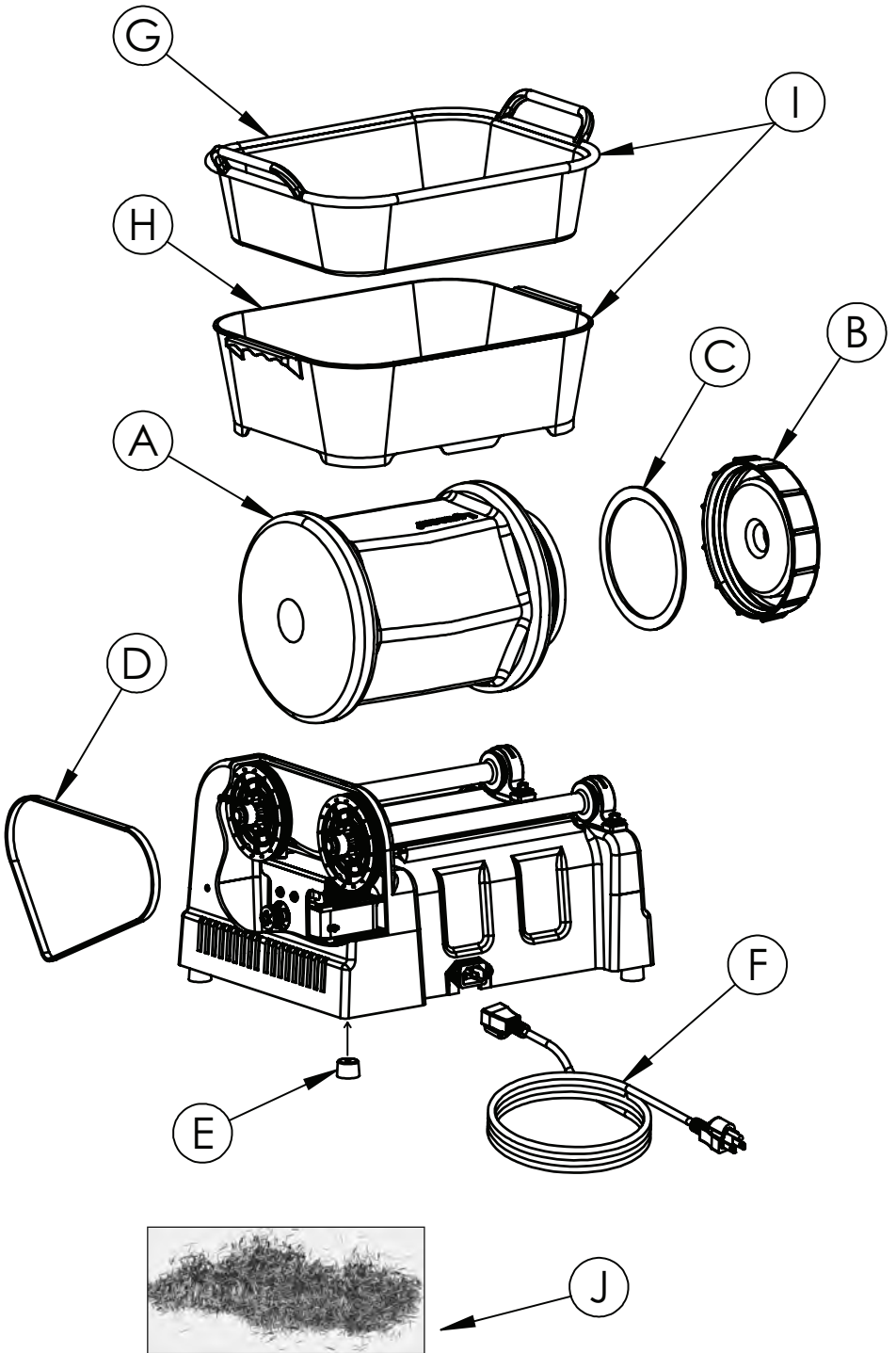

WARRANTY/REPAIR POLICY

Your Lyman Product has been produced under rigid standards of manufacture and inspection. However, if your Lyman product is found to be defective in material or workmanship within one year of delivery to the first retail purchaser, we will repair or replace it without charge.

If you require service under this warranty, please return the complete item along with a letter of explanation, including your complete name and address, freight prepaid to the factory at the address listed below. Your Lyman product will be repaired or replaced and returned to you within 30 days of our receipt. In making any return of a Lyman product to the factory, please be sure it is packaged with proper care to protect it from damage in transit.

We are sorry, but our warranty cannot apply to a defect which results from misuse, abuse, neglect, accident or improper care, or if your Lyman product has been altered or repaired by anyone other than factory personnel.

If the item is out of warranty and is in need of repairs, the Lyman product should also be returned to the same address listed below. Appropriate charges will apply for parts and labor. Estimates are available only when the item has been thoroughly inspected by our repair personnel.

Lyman Products Corporation
475 Smith Street, Middletown, CT 06457
Attn: Service Department

Lyman[®]

475 Smith Street
Middletown, CT 06457

860-632-2020

www.lymanproducts.com



Benn Langlais, Quality Assurance Manager